

SENSO[®]

estal
OFFICIAL DISTRIBUTOR

MOLERY

Modelo registrado/
Registered model/
Modèle enregistré

 Bets

 EXTRA FLINT

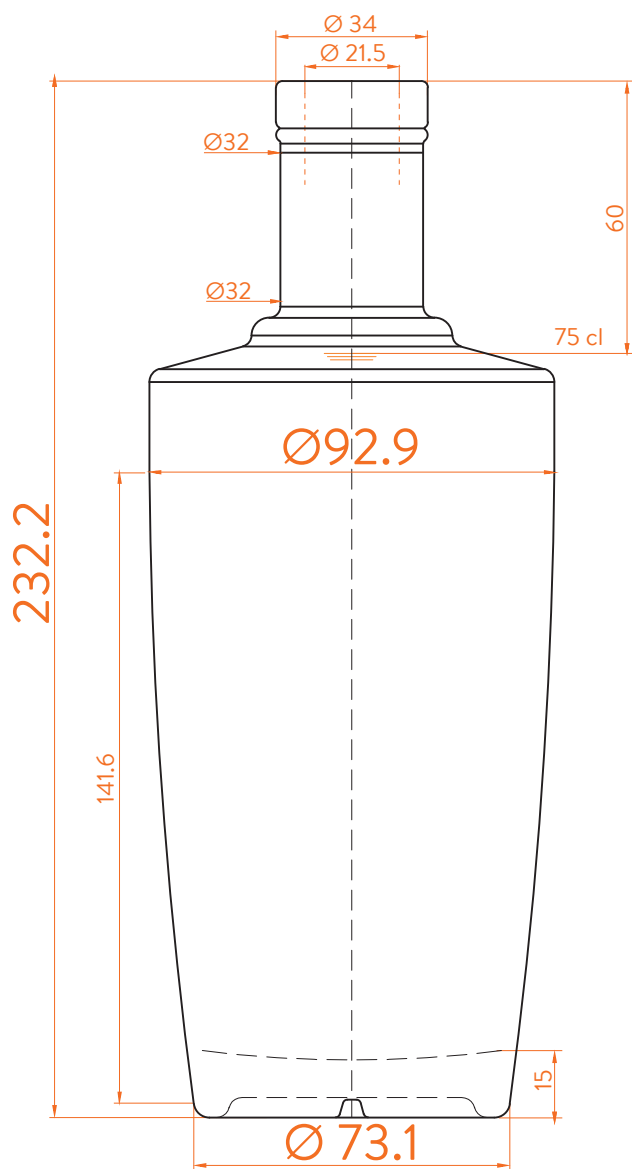

DATOS TÉCNICOS TECHNICAL DATA DONNÉES TECHNIQUES

Peso / Weight / Poids

750 gr

Altura total / Total height / Hauteur totale

232,2 mm

Diámetro del cuerpo / Body diameter / Diamètre du corps

73,1/92,9 mm

Ø interno boca / Ø inner mouth / Ø intérieur bouche

21,5 mm

Capacidad a verter / Brimfull / Capacité Ras-Bord

776 ml

75 cl

At first the SENSO range is proposed in 5, 20, 50, 70 and 75 cl.
Following business opportunities, other sizes - from miniature 5 cl to big sizes 300 cl will be added to the range.

The elements detailed in this document are not contractual. They are only indicative.