

DA CLARIOR®

estal
OFFICIAL DISTRIBUTOR

MOLERY

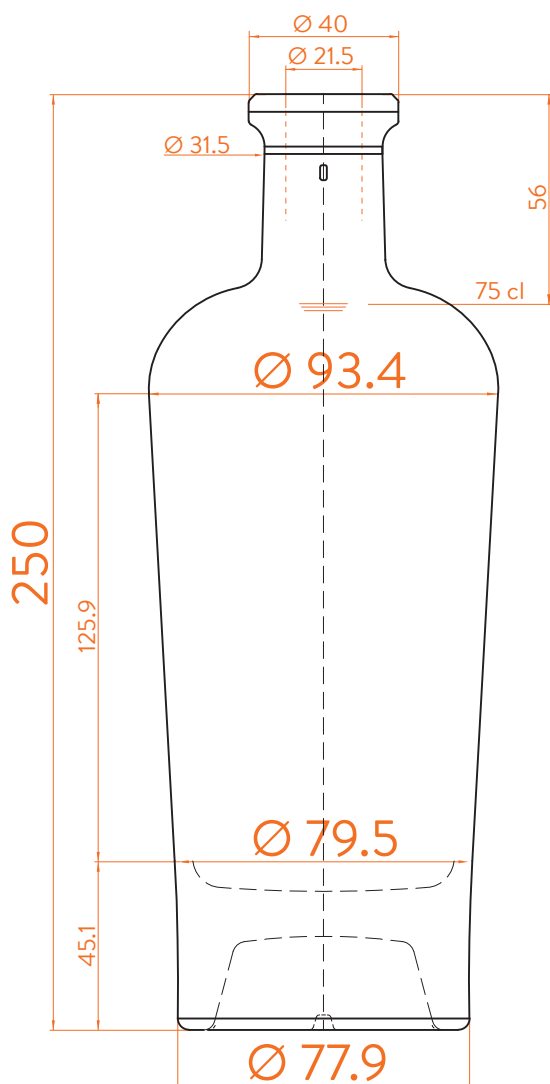

Modelo registrado/
Registered model/
Modèle enregistré

 Cork Special

 EXTRA FLINT



DATOS TÉCNICOS TECHNICAL DATA DONNÉES TECHNIQUES

Peso / Weight / Poids

850 gr

Altura total / Total height / Hauteur totale

250 mm

Diámetro del cuerpo / Body diameter / Diamètre du corps

77,9 / 93,4 mm

Ø interno boca / Ø inner mouth / Ø intérieur bouche

21,5 mm

Capacidad a verter / Brimfull / Capacité Ras-Bord

75 ml

75 cl

At first the DA CLARIOR range is proposed in 70 and 75 cl.

Following business opportunities, other sizes - from miniature 5 cl to big sizes 300 cl will be added to the range.

The elements detailed in this document are not contractual. They are only indicative.